

Data Sheet



Article number: 021816011100

Description: Clamp with bracket and rubber
SPGU 6011. 100/30 SK

Measures

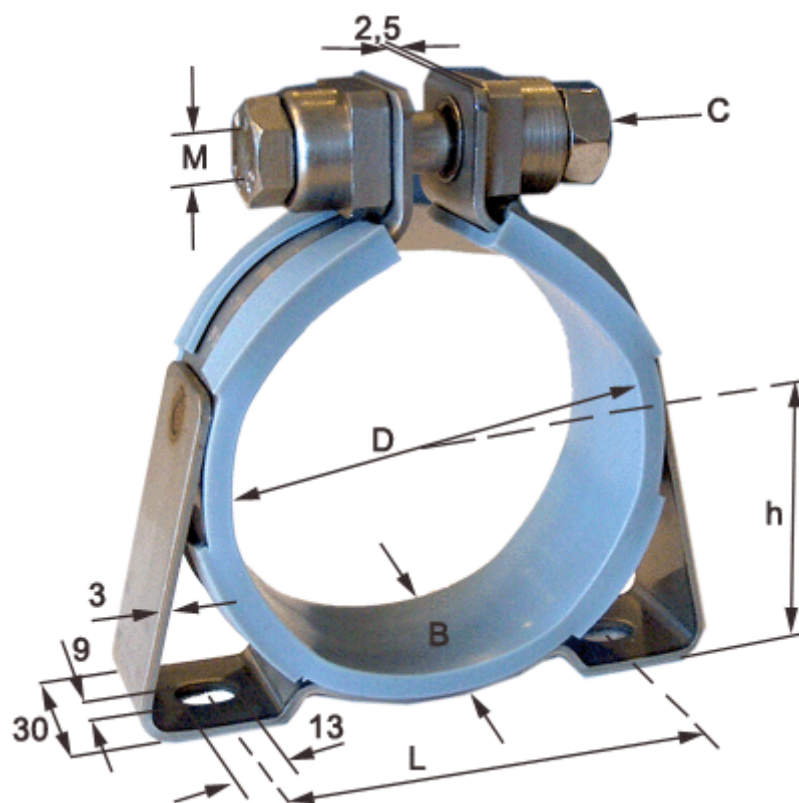

C (screw type) = SK hexagon screw

Diameter D = 100

h = 58

L = 90

Width B = 30